

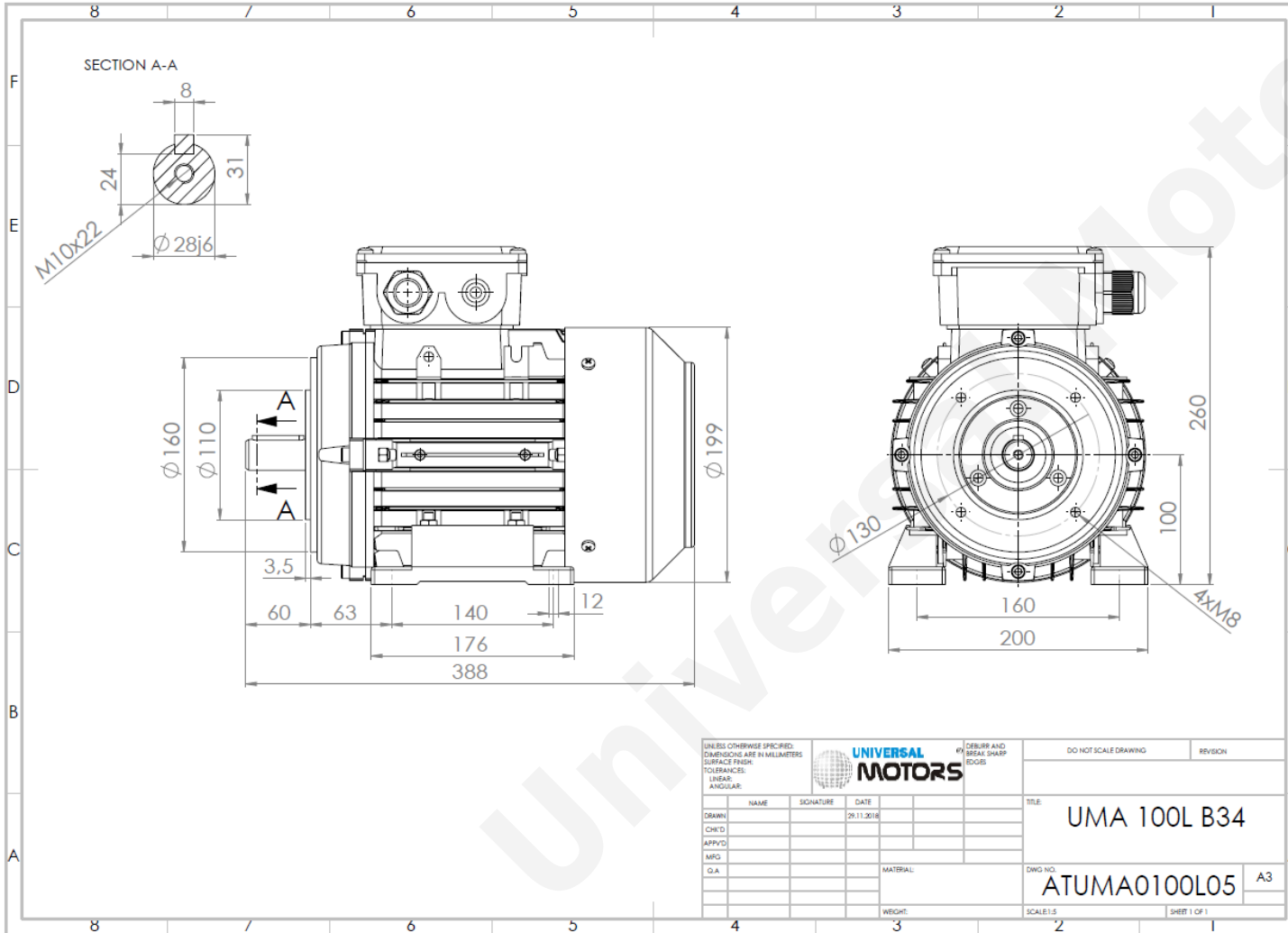

TECHNICAL DATA

Three Phase Electric Motors - Aluminum Frame
 UM3A 100L2-6 IE3
 2.2 kW / 3 Cv
 955 RPM



Motor type:	UM3A 100L2-6 IE3
Output:	2.2 kW / 3 Cv
Speed (min ⁻¹):	955 RPM
Frequency:	50 Hz
Voltage:	400 V
Current:	5.23 A
Power factor (Cos Ø):	0.72
Poles:	6
Insulation class:	F
Temperature rise Class:	B
Efficiency 50%:	83.9 %
Efficiency 75%:	85.1 %
Efficiency 100%:	84.3 %
Torque:	22 N.m
Tstarting/Tnominal:	2.5
Istarting/Inominal:	6.2
Tmaximum/Tnominal:	3.0
Noise:	64 Db(A)
Weight:	27.7 Kg
Brake AC:	AC5
Torque Brake DC:	32 N.m
Bearing DE:	6206 2Z
Bearing NDE:	6206 2Z
Torque Brake AC:	40 N.m
Brake DC:	REB-05-12

Regime - S1

Altitude - 1000m

Environment Temperature - 40°C

CONTACTS:

UNIVERSAL MOTORS Tel: +351 252 299 080
 Rua de São Brás,745 Fax: +351 252 299 089
 4480-782 VILA DO CONDE Mail: geral@universalmotors.pt

* References applied only in the UK